

# **Transmission and Control of Seasonal and Pandemic Influenza**

**DIMACS Workshop on Models of Co-Evolution of  
Hosts and Pathogens**

**October 10, 2006**

**Gerardo Chowell**

**Mathematical Modeling and Analysis Group &  
Center for Nonlinear Studies  
Los Alamos National Laboratory**

# Part I: Seasonal Flu in the US, France and Australia

- First systematic study to explore seasonal flu transmissibility for several consecutive influenza seasons in the inter-pandemic period in several countries.
- Sensitivity of transmissibility estimates obtained from mortality data.
- Temporal variability of flu transmissibility across countries and their association to circulating influenza subtype.
- Public health implications on seasonal influenza control.

# The basic reproduction number $R_0$

- The number of secondary cases generated by a primary infectious case during its period of infectiousness in an entirely susceptible population is known as the **basic reproduction number  $R_0$** .
- A more practical quantity is the **reproduction number ( $R$ )** which measures the transmissibility in a partially immune population, where a fraction of individuals is effectively protected against infection before the start of the epidemic, because of residual immunity from previous exposure to influenza, or vaccination. For example, if a proportion  $p$  of a completely susceptible population is successfully immunized prior to an epidemic, the relation between the basic and the effective reproductive number is  $R = (1-p) R_0$ .

# Mortality data for seasonal influenza

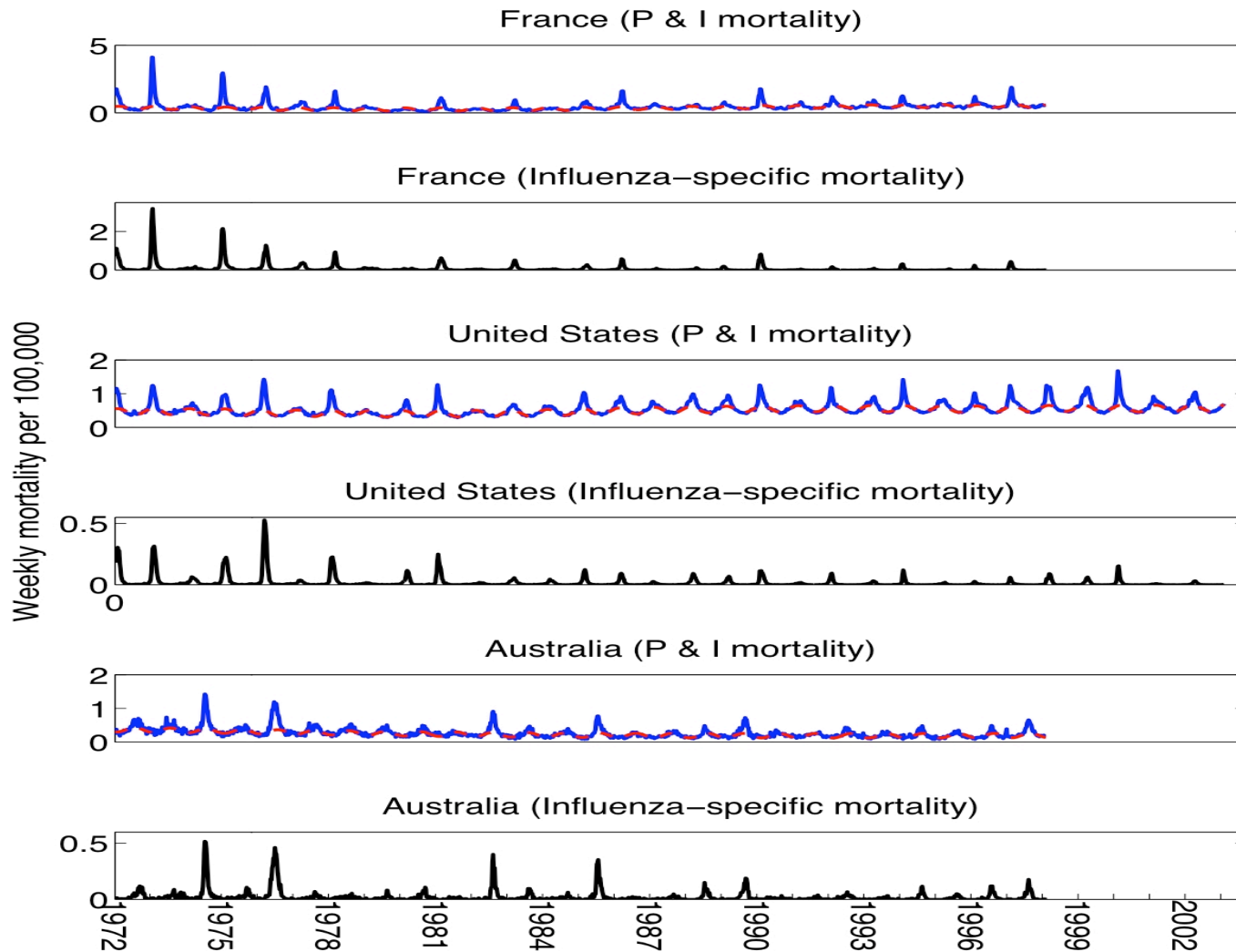

*Serfling (1963); Simonsen (1999); Reichert et al. (2004); Viboud et al. (2006)*

# SEIR model

Kermack and Mackendrick, 1927

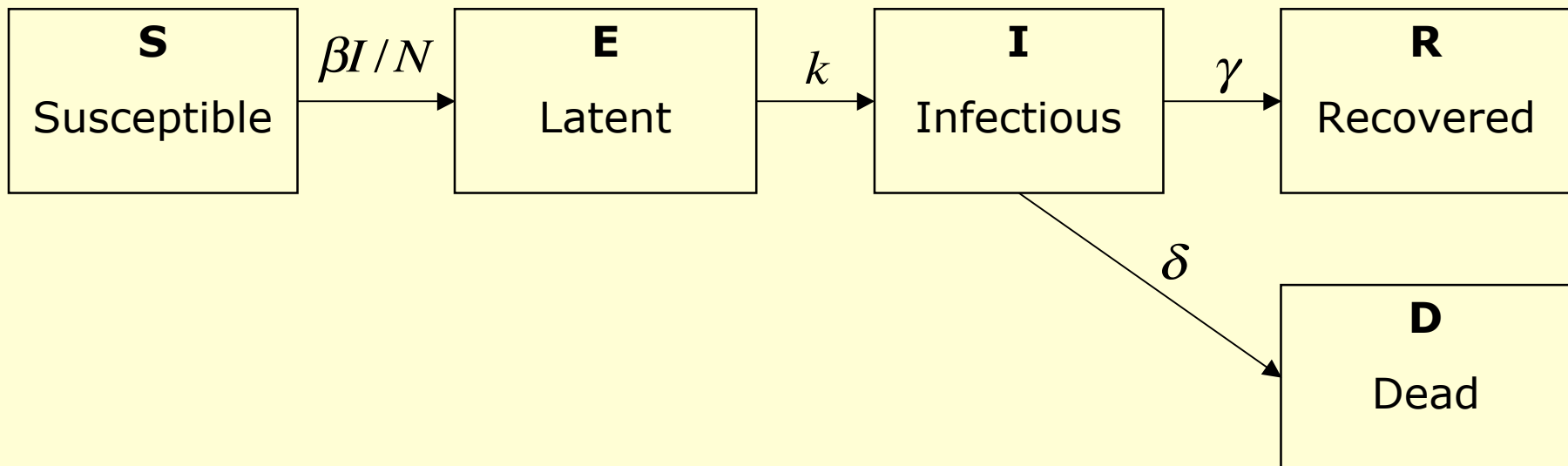

$\beta$  = Transmission rate;  $N$  = total population size;  $1/k$  = Latent period;  $1/\gamma$  = Recovery period;  $\delta$  = Mortality rate.

# Model parameters

Parameter	Definition	Source	Estimate	Range
1/k	Latent period	Mills et al., 2004	1.9 days	
1/γ	Recovery period	Mills et al., 2004	4.1 days	
CFP	Case fatality proportion	Weycker et al., 2005; Mills et al., 2004	0.20%	0.1% - 0.4%
δ	Mortality rate	$\gamma [CFP/(1-CFP)]$	0.0005 per day	0.0002- 0.001
S(0)	Initial number of susceptible individuals	Census data	Entire population size	
β	Transmission rate	Estimated		
E(0)	Initial number of exposed cases	Estimated		
I(0)	Initial number of infectious cases	Estimated		

# Model fits for a number of influenza seasons

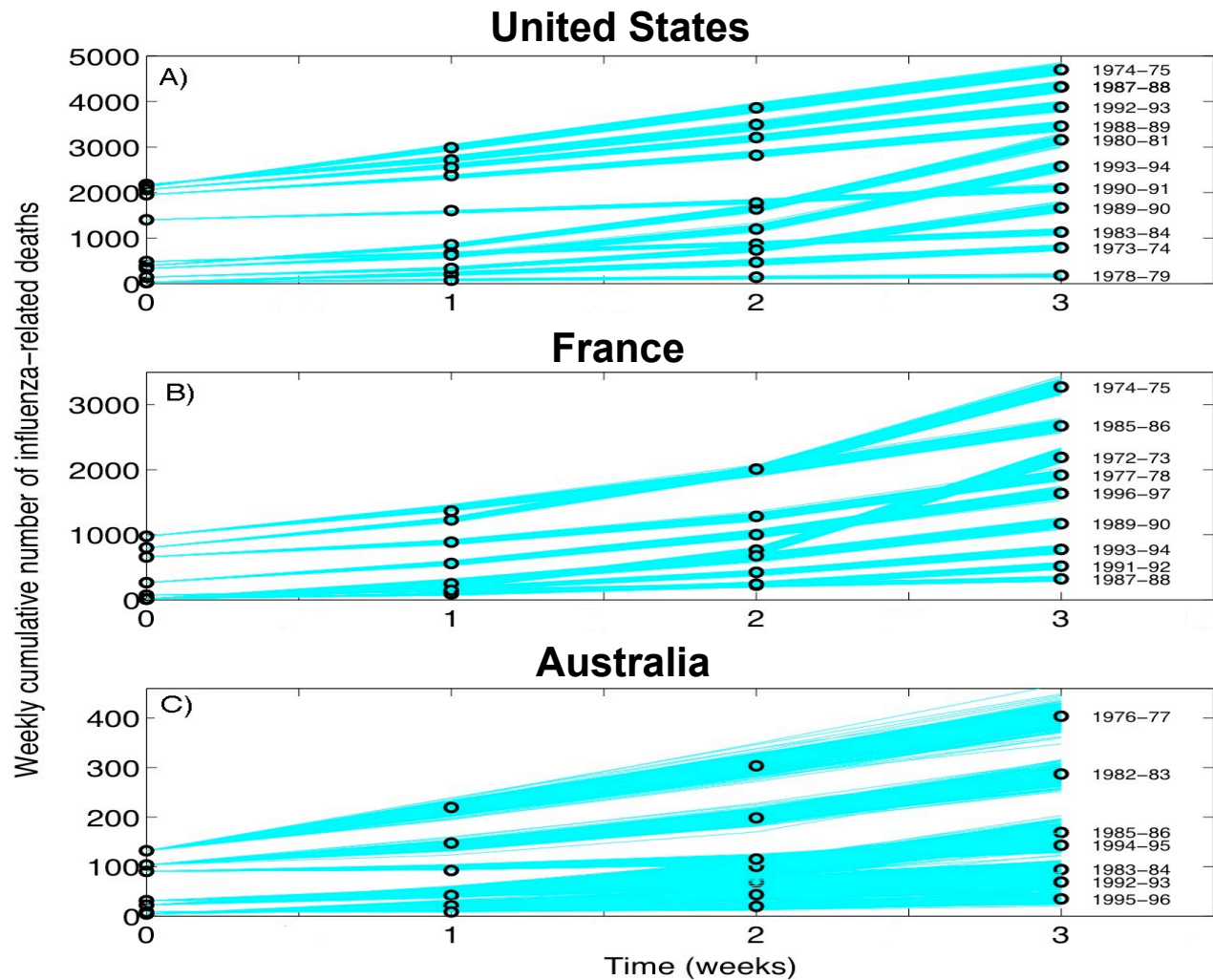

# Reproduction number, $R$ , derived from P & I mortality data

United States

France

Australia

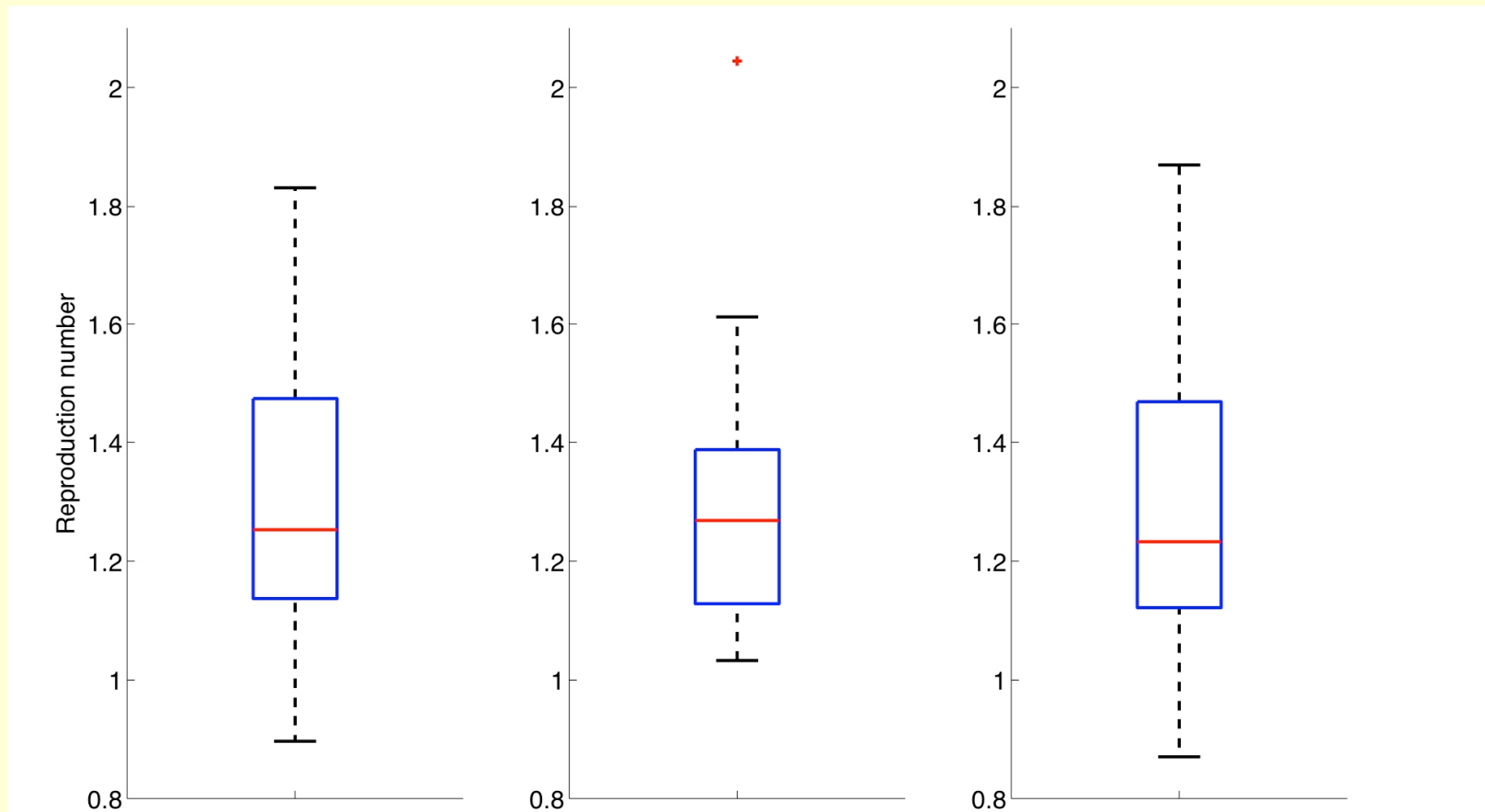

*Chowell, Miller, Viboud. Seasonal Influenza in the United States, France, and Australia: Transmission and prospects for control (in revision).*



# Correlating R from P&I and influenza-specific mortality data

United States ( $\rho = 0.61$ ;  $P < 0.001$ )

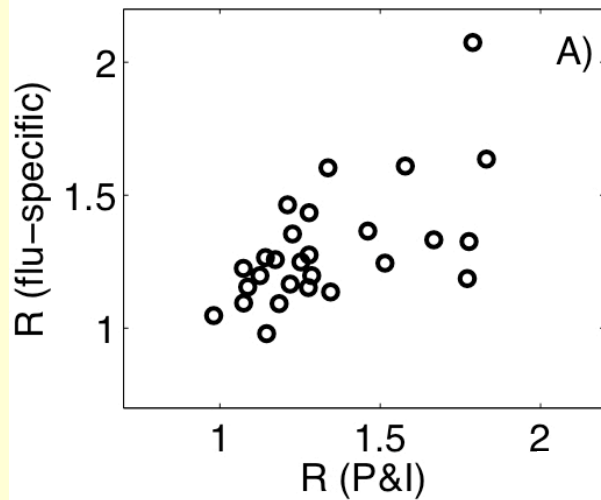

France ( $\rho = 0.79$ ;  $P < 0.001$ )

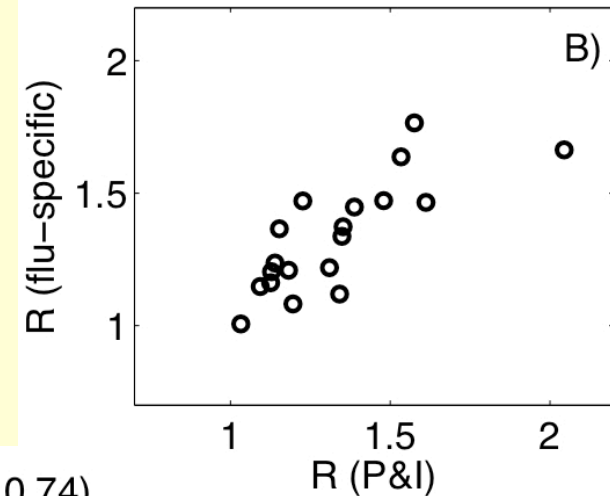

Australia ( $\rho = 0.17$ ;  $P = 0.74$ )

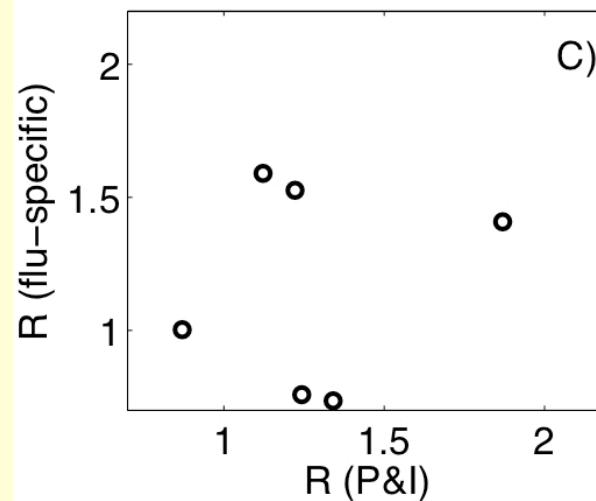

# Sensitivity analyses

1. Number of weeks comprising the increasing epidemic phase
2. More realistic latent and infectious period distributions
3. Changes in case fatality proportion (0.1-0.4%)
4. More extreme observation error where variance is 2,3, or 4-times the mean.

# Sensitivity analysis on number of epidemic weeks

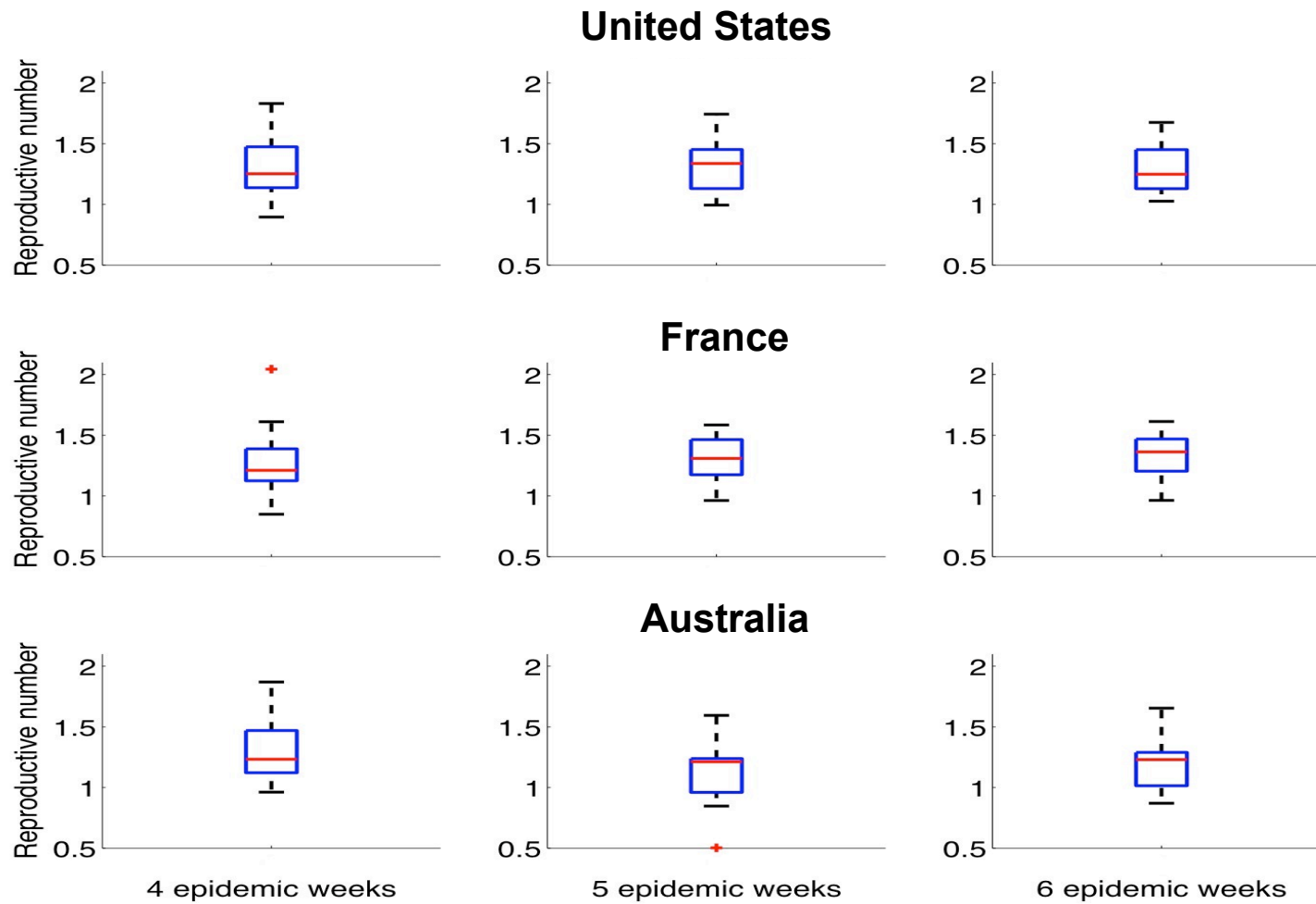

# Sensitivity analysis on latent and infectious period distributions

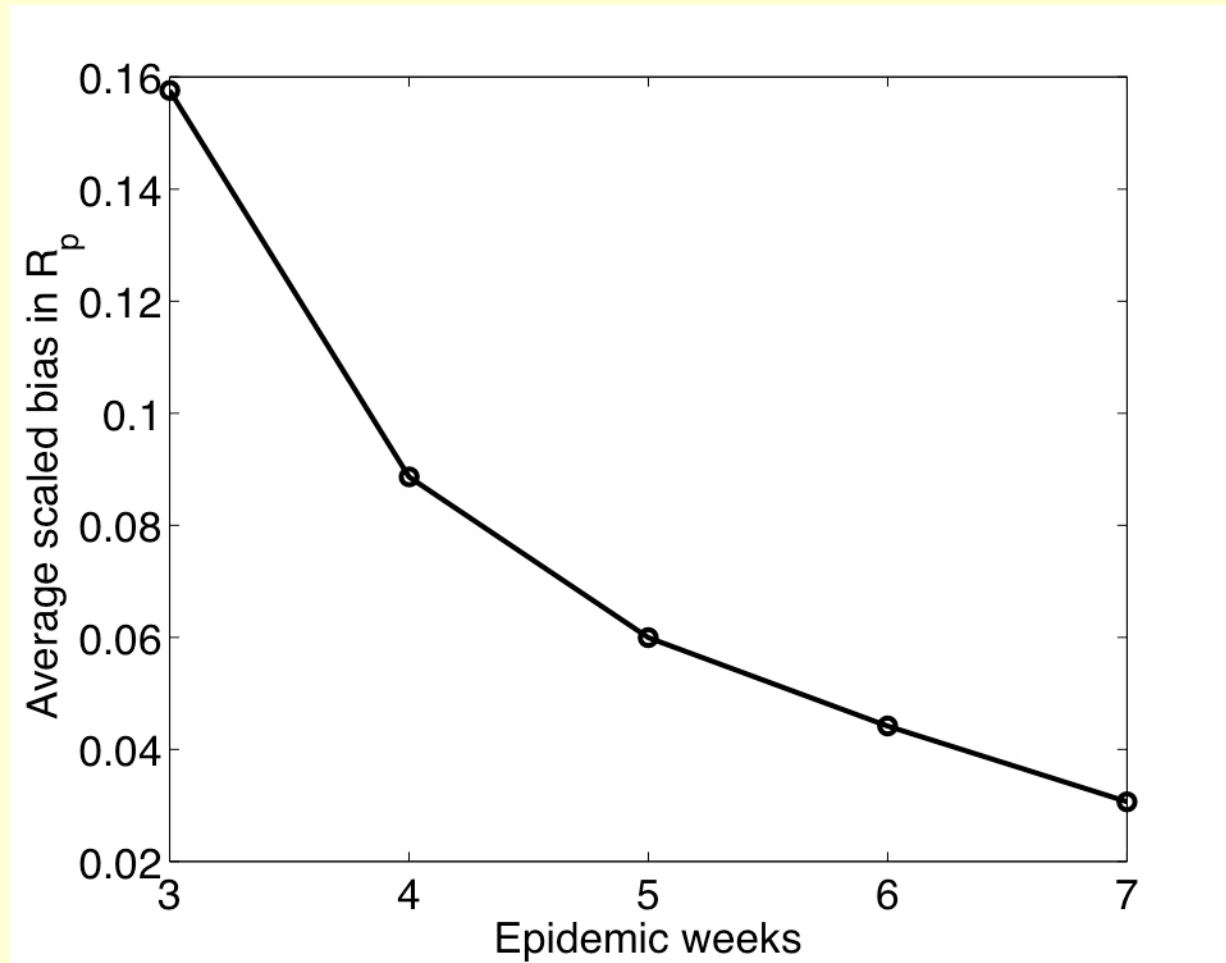

# Joint likelihood ratio confidence bounds

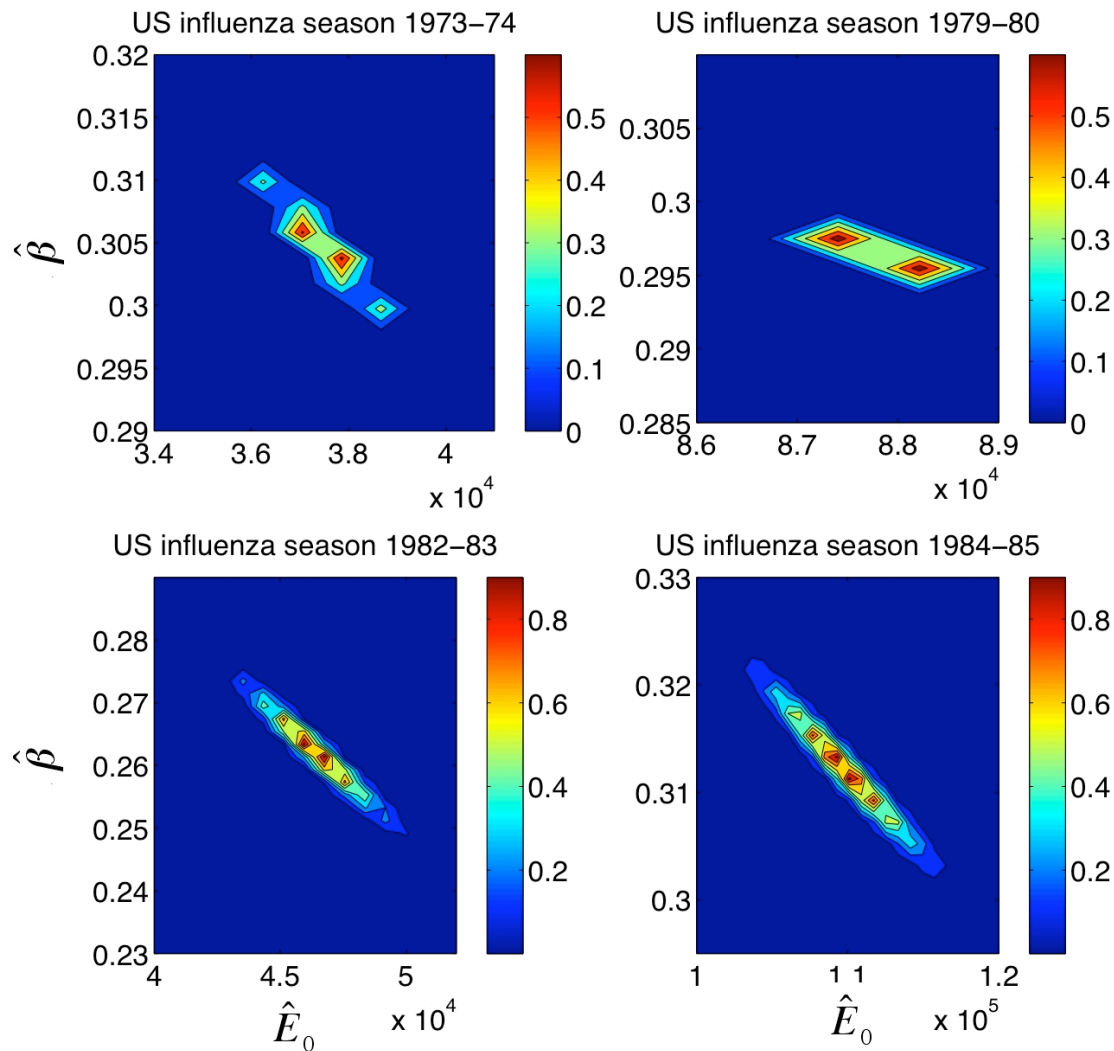

## Previous R estimates for single seasons

- Our results are in overall agreement with a previous study that analyzed a single season: In the inter-pandemic period of A/H3N2 virus circulation, the reproduction number was estimated at 1.5 during the 1984-85 epidemic in France (Flahault et al., 1998). One early study has evaluated the reproductive number for several consecutive influenza seasons in England and Wales, and reported estimates between 1.4 and 2.6 (Spicer, 1984), which is higher than our estimates.

# Association of R with epidemic peak, size, and influenza viruses

- There is a moderate correlation between R and the mortality impact (Spearman  $\rho=0.47$ ,  $P=0.01$ ) and a stronger correlation with the magnitude of the peak (Spearman  $\rho=0.60$ ,  $P=0.0001$ ).
- We found that high influenza transmission seasons, associated with high effective reproductive number, are dominated by A/H3N2 viruses ( $P=0.006$ ), the fastest evolving influenza subtype, while low transmission seasons are associated with B viruses ( $P=0.004$ ), the slowest evolving subtype.

# Controlling seasonal flu

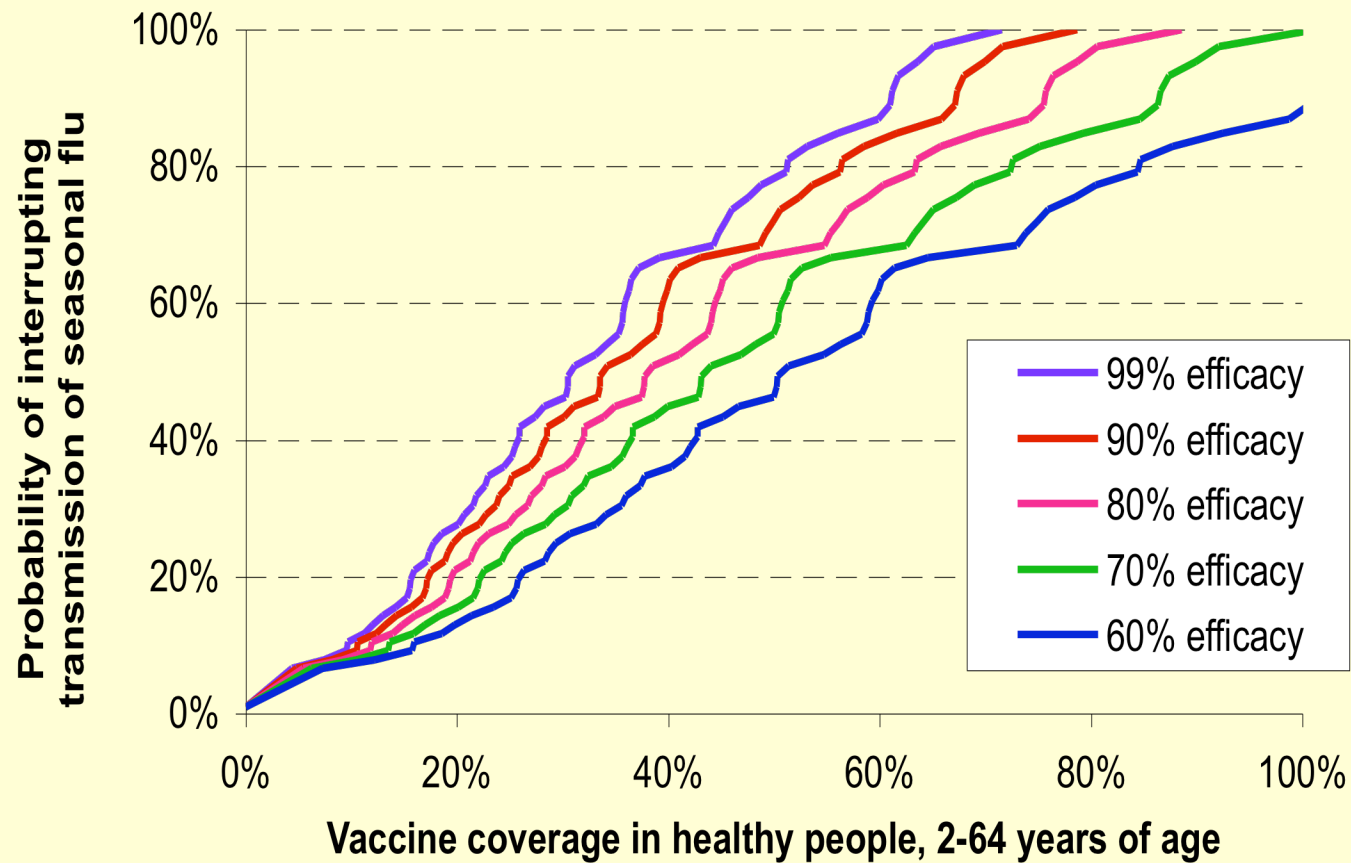

*Chowell, Miller, Viboud. Seasonal Influenza in the United States, France, and Australia: Transmission and prospects for control (in revision).*



## Part 2: The 1918 Influenza Pandemic or “Spanish Flu”

- Brief review of the 1918 influenza pandemic.
- Historical hospital notification data of the 1918 influenza pandemic in Geneva, Switzerland.
- Compartmental pandemic influenza model to estimate the transmissibility of the 1918 pandemic.
- The role of hypothetical interventions on the transmissibility of the 1918 pandemic.

# US mortality in 20th century

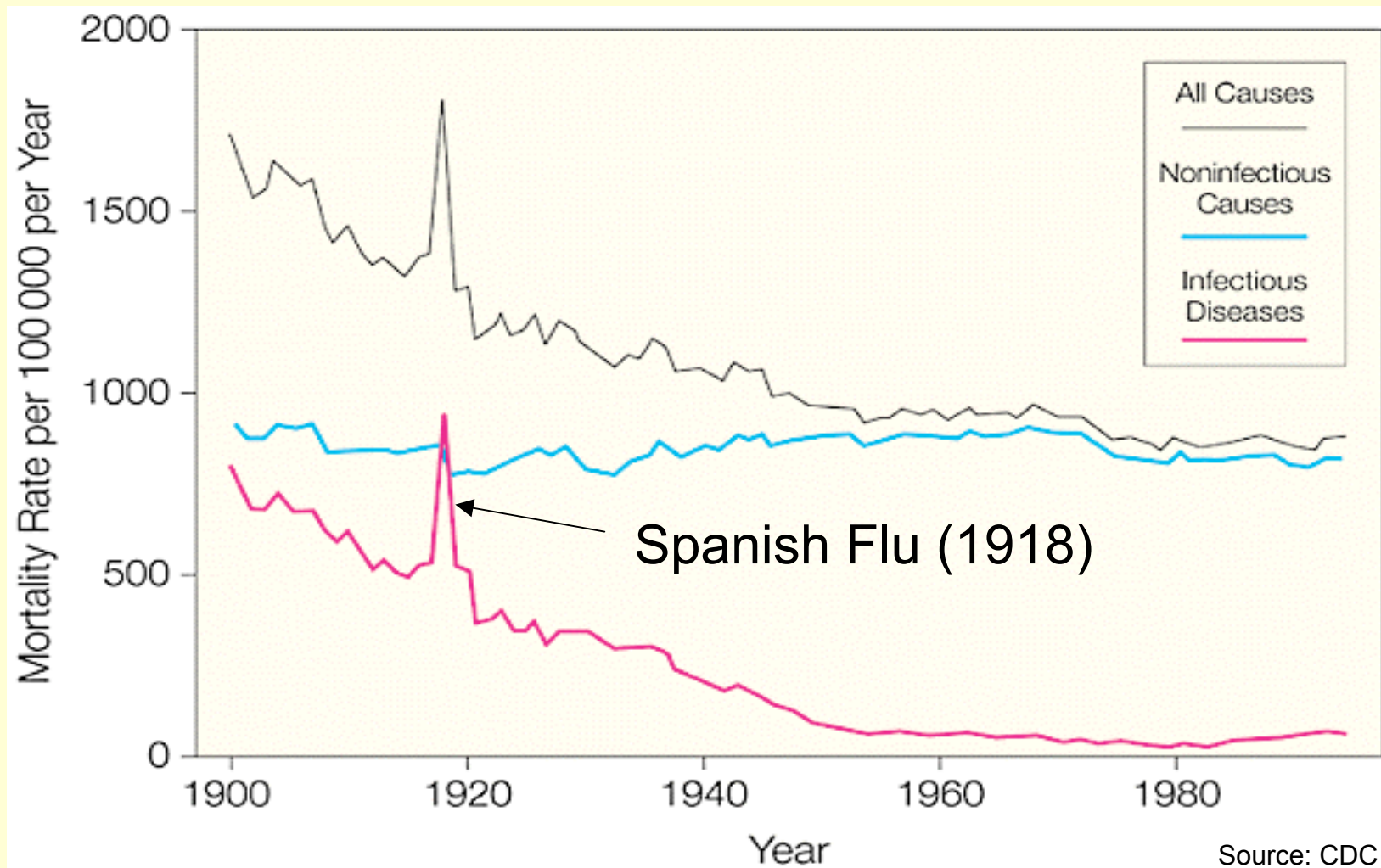

# Characteristics of the 1918 pandemic

- Caused by the influenza virus H1N1.
- 20-100 million deaths in the world.
- In the US, 675 000 deaths (population was about a quarter of what it is now).
- Killed 2-4% of those infected (risk of death 10x greater than “regular” flu).
- Roughly 1 billion infections in the world.

# Mortality pattern

- Young adults were most affected.
- Unlike regular mortality patterns of influenza, mortality rates in the elderly were significantly smaller than in the other age groups probably because a similar strain circulated in the mid 1800s.



C. Mörgeli. NZZ Folio 11, 1995.

*Reid AH, Taubenberger JK, Fanning TG. The 1918 Spanish influenza: integrating history and biology. Microbes Infect. 2001; 3, 81-7.*

# Clinical symptoms

- Influenza infection starts before the appearance of clinical symptoms (for about 1 day)
- Fulminant forms: Cyanosis (many died within 24hrs of symptoms appearance)
- Fever, non-productive cough

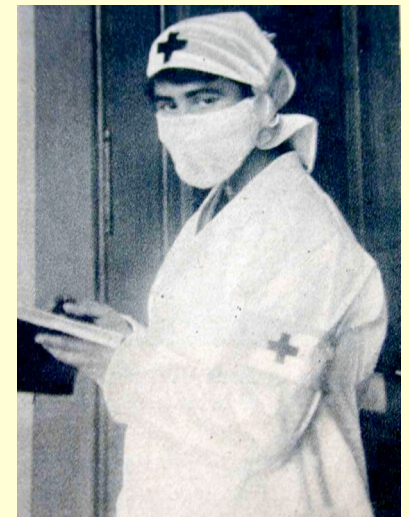

Courtesy of C. Ammon

# Private and public sectors

- Disruptions in hospitals were common
- There was a climate of insecurity and fear
- 80% employees sick
- Health care workers sick and dying
- 50% army medical staff sick



Courtesy of C. Ammon

# Private and public sectors

- Limited public transportation
- Closing of schools
- Banned public meetings and gatherings
- In Geneva, only one of 3 trams were operating, ie 3x more people = easy transmission of virus in overcrowded tramways.



Courtesy of C. Ammon

# Pandemic in Geneva, Switzerland

- 3 waves: July – October - December
- Start among soldiers
- Spread to civilians

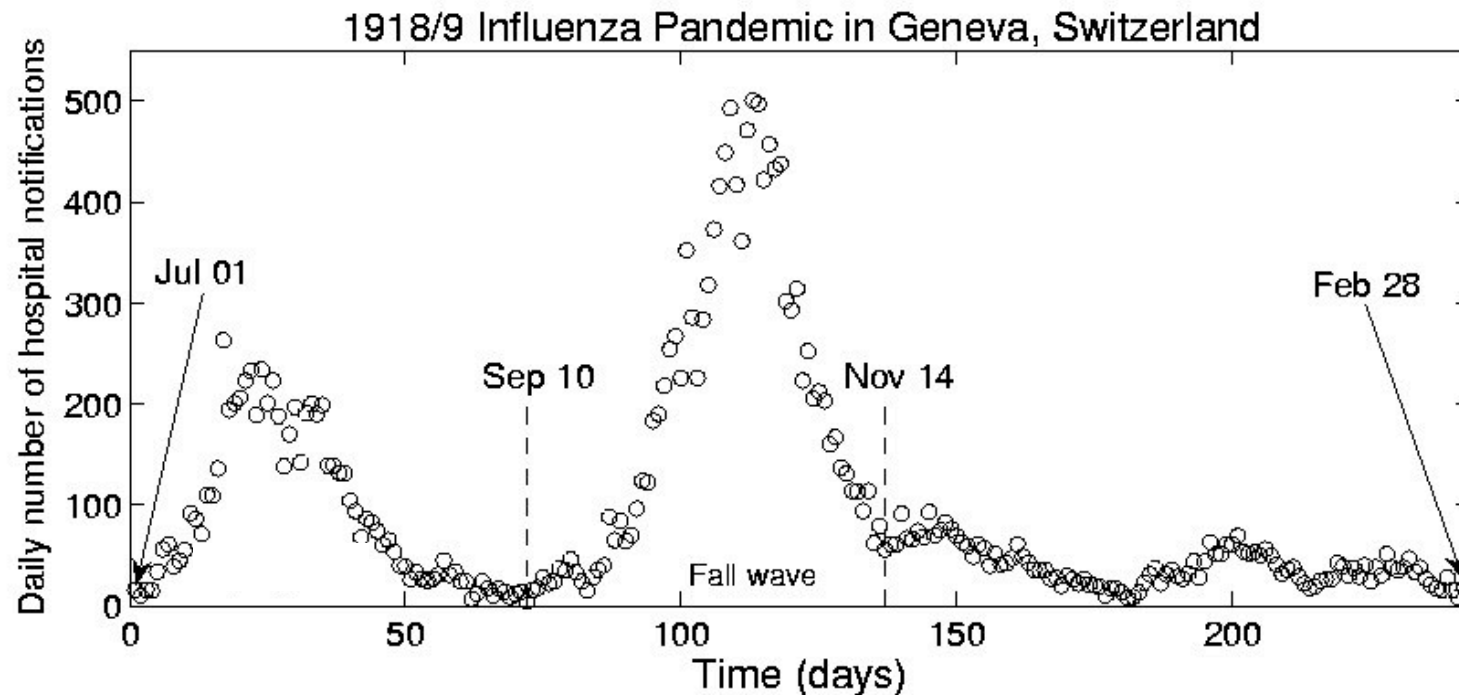



# Immunity

- It seems that individuals that recover from the first flu wave were protected to the second wave [*Cottin E, Gautier P, Saloz C. La grippe de 1918. Ses formes cliniques. Revue Suisse de Médecine 1919; 24, 472-496*]
- *Anonymous. The influenza Pandemic. The Lancet, March 6, 1919. p. 386- 387:* This reference states “Many observers affirm that those persons who suffered from influenza in June and July escaped infection during the subsequent autumn epidemic.”

# Model for pandemic flu

Our "Observed" data

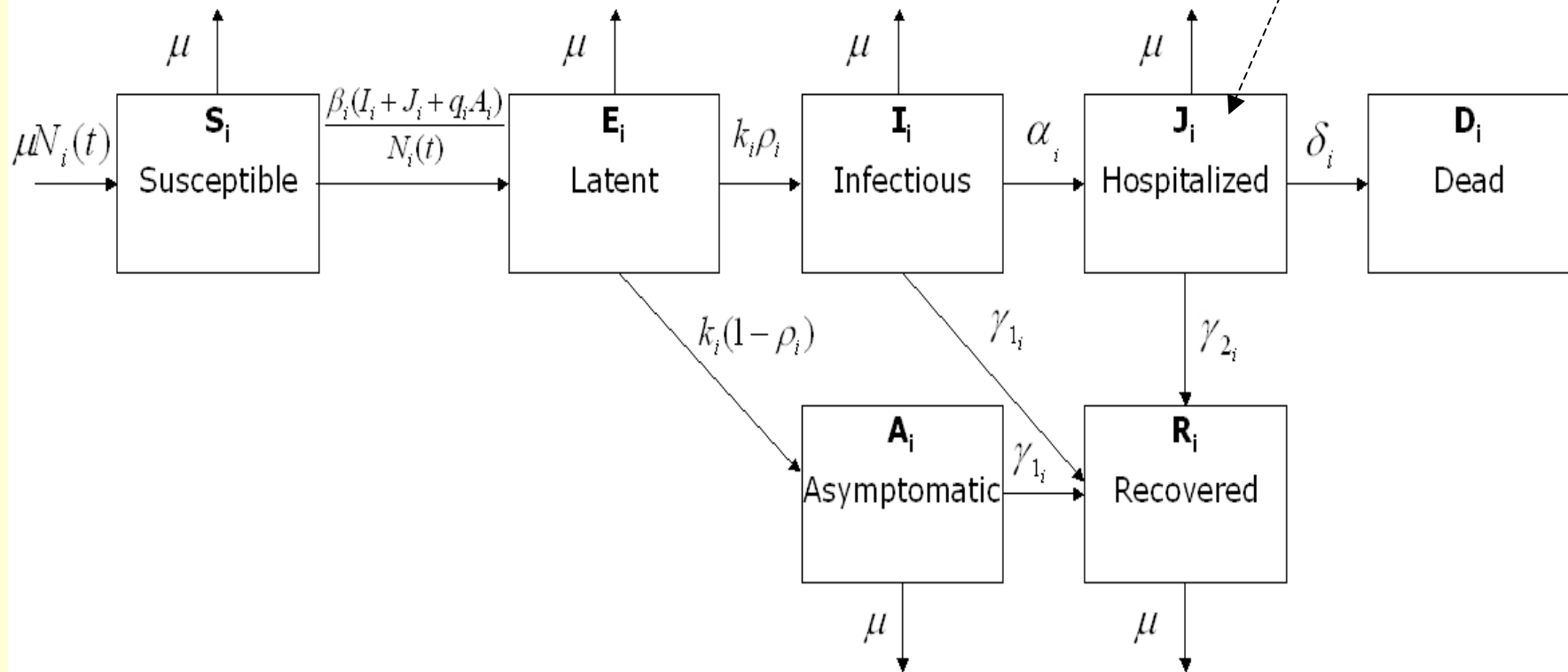

# Model fit

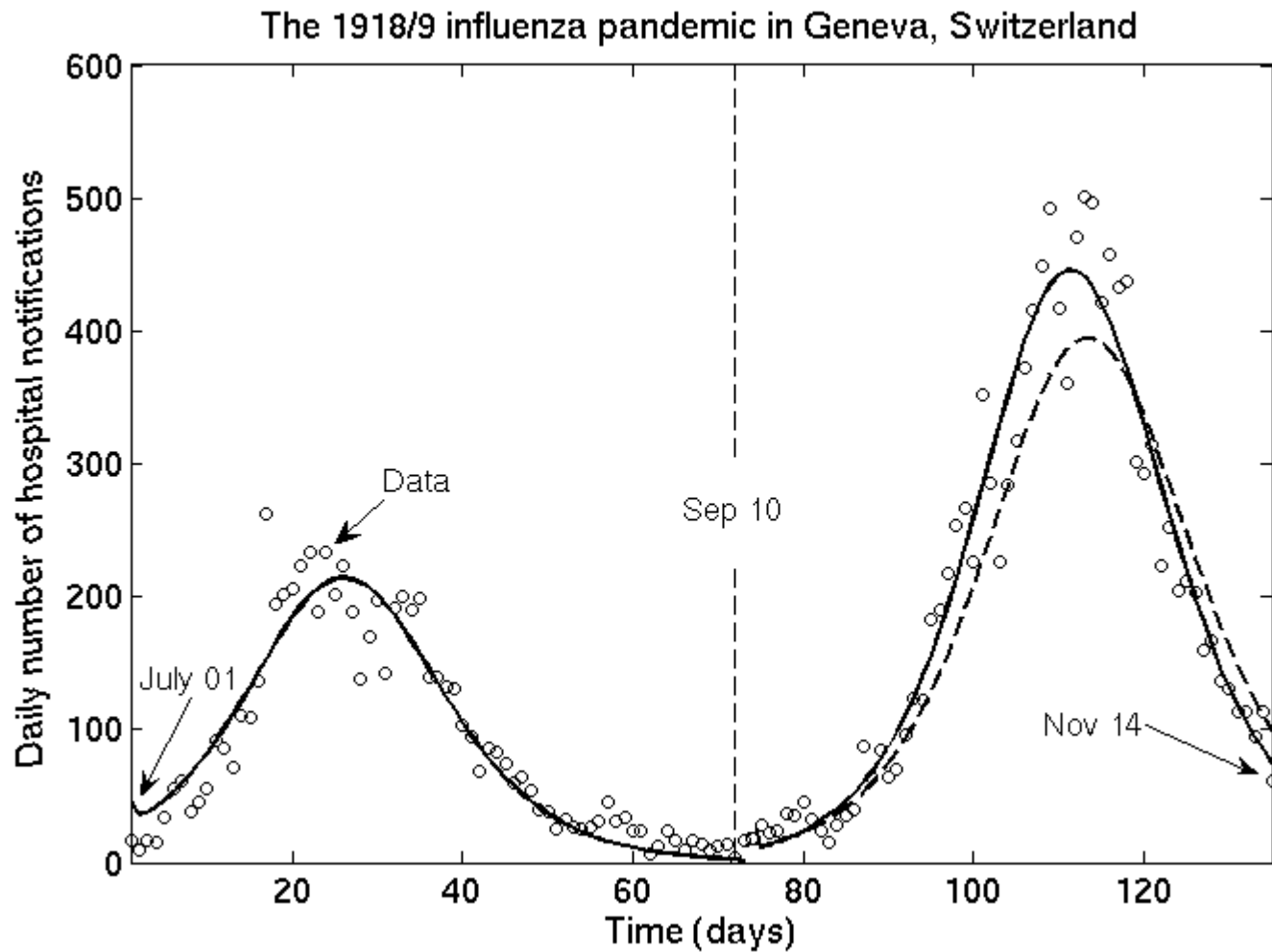

# Reproduction numbers and reporting rates

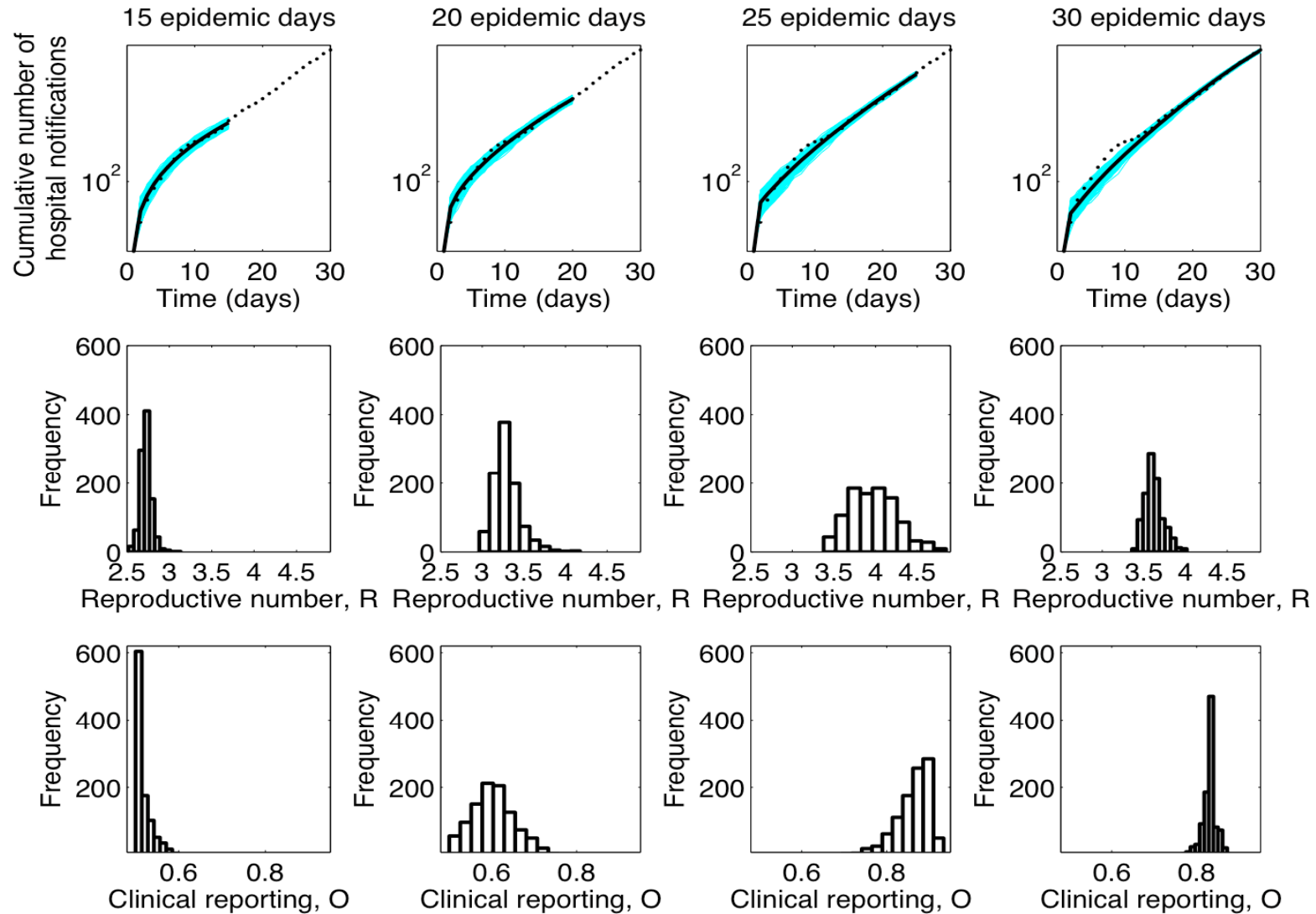

# The reproduction number

$$R_i = R_i^{\text{infectious}} + R_i^{\text{hospitalized}} + R_i^{\text{asymptomatic}}$$

<b>Flu wave</b>	<b>Case fatality (%)</b>	<b>R</b>	<b>S.D. R</b>	<b>Reporting (%)</b>	<b>S. D. Reporting (%)</b>
<b>1st wave</b>	0.7	1.49	0.02	59.7	2.0
<b>2nd wave</b>	3.25	3.75	0.09	83.0	2.0

# Efforts to estimate R from pandemic morbidity data

- Rvachev and Longini, Math. Biosci. (1985). Estimated  $R \sim 1.9$  for the influenza H3N2 pandemic of 1968 in Hong Kong from the ascending limb of the epidemic curve.

# Efforts to estimate R for pandemic flu from mortality data

- Mills et al., Nature (2004). SEIR model fit to influenza deaths extracted from pneumonia and influenza mortality.  $R \sim 2-3$  around 10 major US cities.
- Gani et al. Emerg. Inf. Dis. (2005) in the UK estimated an R of 2 for the first wave and 1.5 for the second wave.

# Effects of two hypothetical interventions

1. Effective isolation of infectious individuals in hospital settings (reduction factor *l*)
2. Reductions in the susceptibility of the general population through for example, increasing hygiene and protective measures (e.g., increase hand washing, use of face masks), prophylactic antiviral use, and vaccination (reduction factor **p**).

$$\mathbf{R_c} = \mathbf{p} \times \mathbf{R_2}^{\text{infectious}} + \mathbf{p} \times \mathbf{l} \times \mathbf{R_2}^{\text{hospitalized}} + \mathbf{p} \times \mathbf{R_2}^{\text{asymptomatic}}$$



# The effects of two types of interventions

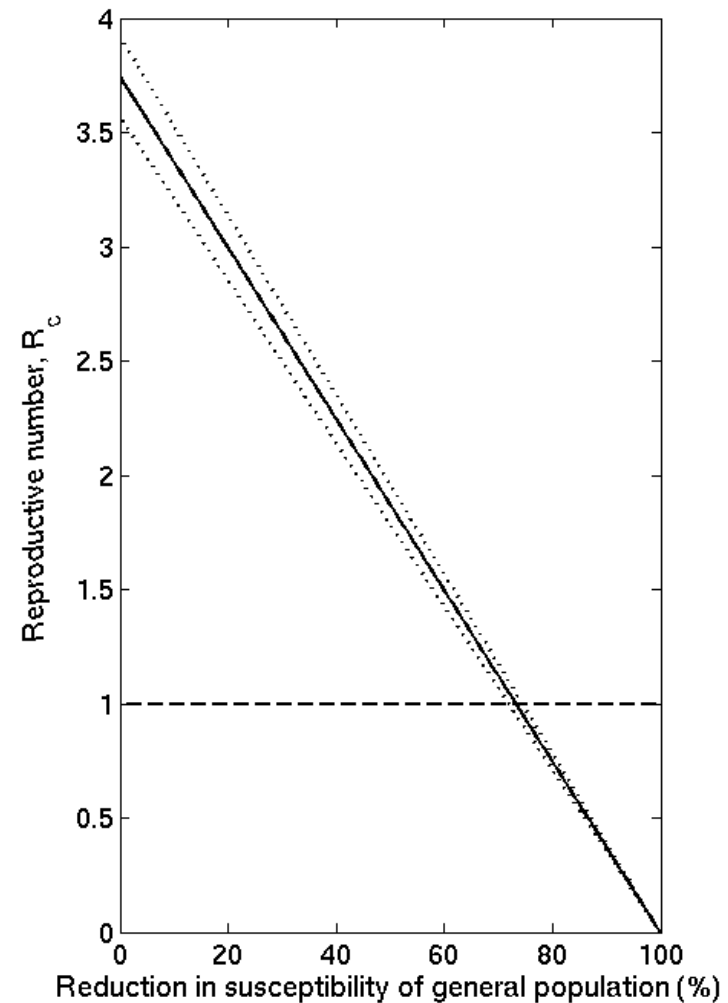
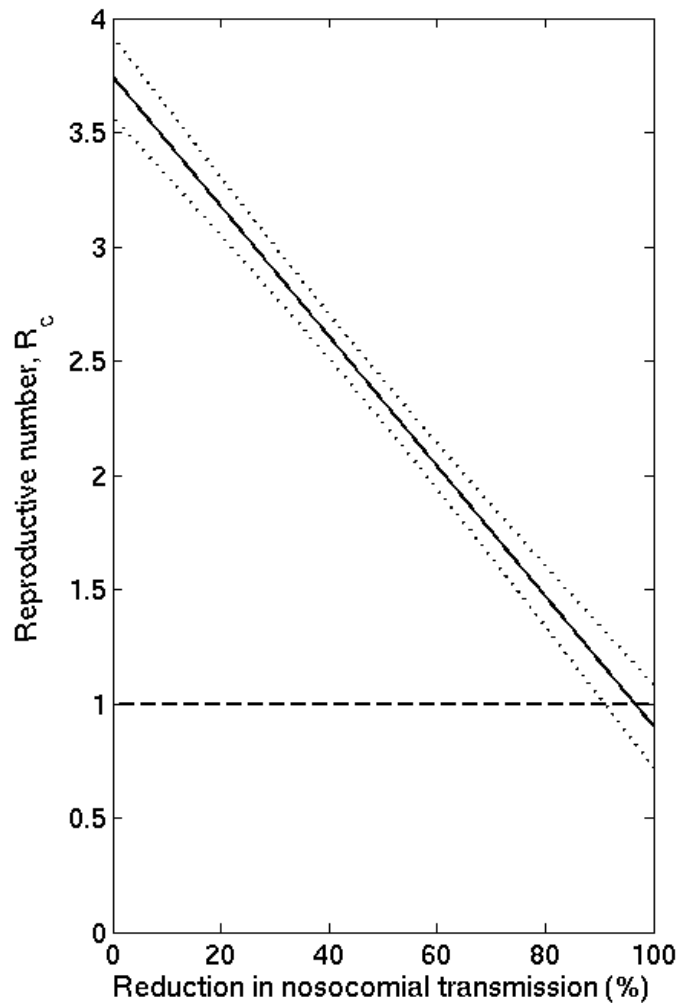

# Combined interventions

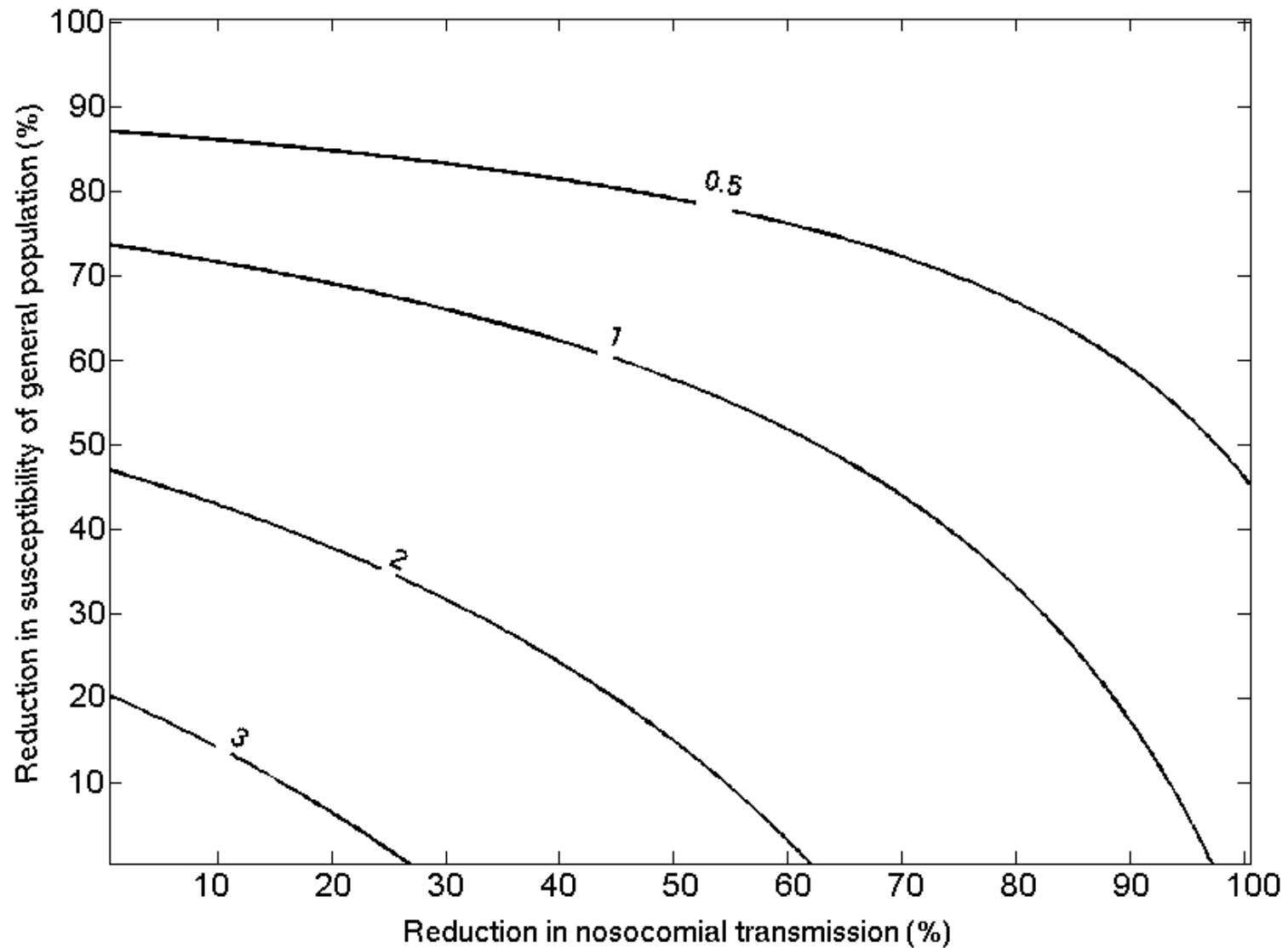

# 1918 influenza pandemic in San Francisco, California

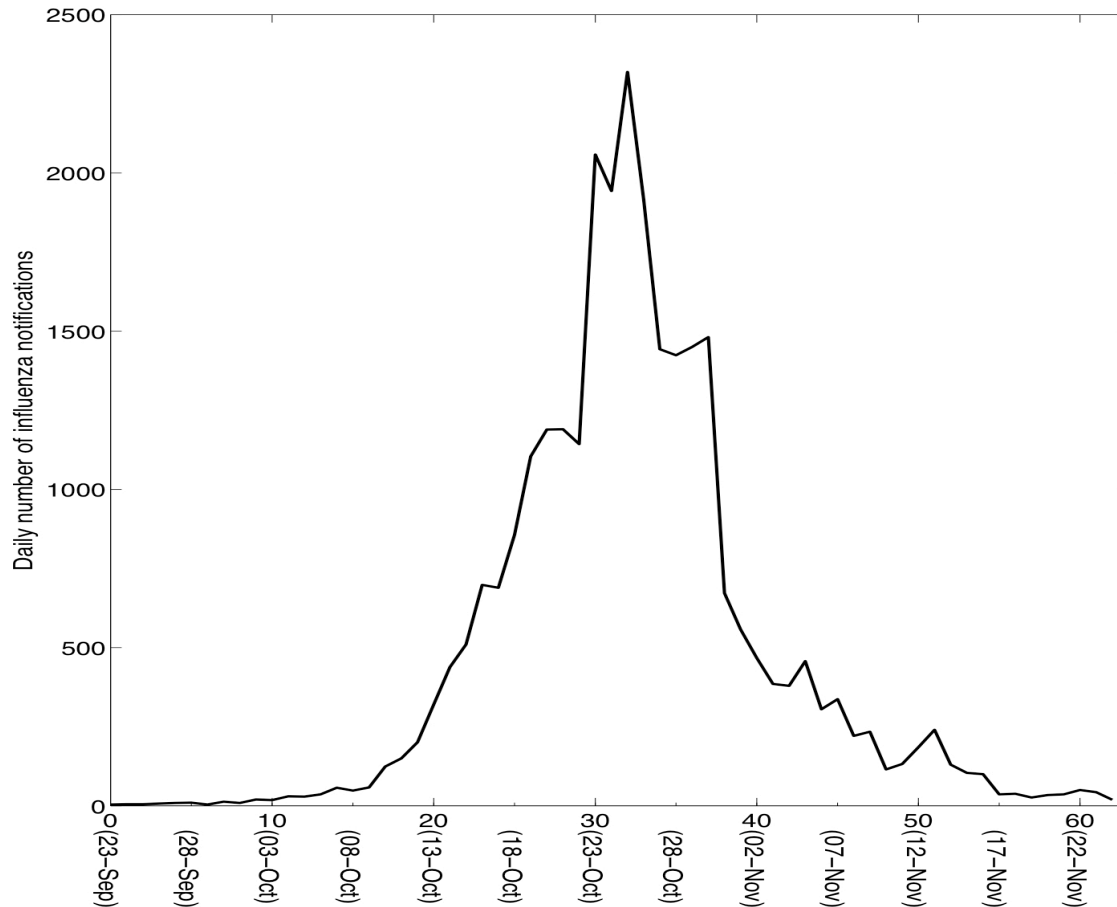

$R \sim 2-3$

Four different methods:

1. Initial growth rate
2. Simple SEIR model
3. Complex SEIR model
4. Stochastic SIR model

## Some concluding remarks

- The reproduction number of the Spanish Flu pandemic is approximately twice larger than that of seasonal flu.
- The reproduction number of the first (herald) pandemic wave in Geneva is in agreement with that of seasonal flu.
- The consistency of mean and variance estimates of  $R$  confirms that long-term influenza mortality records can be used to study patterns of disease transmission.
- Vaccination coverage in healthy individuals (2-64 y) needs to be relatively high to interrupt transmission of seasonal influenza every year.

## Some concluding remarks

- In the presence of the next influenza pandemic, it will be very likely necessary the enforcement of public health measures (isolation in hospital settings, use of face masks, and antiviral treatment).
- Hospitals need to be prepared for high patient burden.
- Need to increase antiviral stockpile, improve vaccine technology and surveillance specially in Asia.